



PFC Device Corporation

PRM010N12CT

120V Single N-Channel MOSFET

Major ratings and characteristics

Characteristics	Values	Units
V_{DS}	120	V
I_D ($T_C=25^\circ\text{C}$)	71.8	A
Max. $R_{DS(ON)}$ @ $V_{GS}=10\text{V}$	10	m Ω
T_J Operating Junction Temperature	-55 to +150	$^\circ\text{C}$

General Description

The N-Channel enhancement mode power field effect transistor is using trench DMOS technology. This advanced technology has been especially tailored to minimize on-state resistance, provide superior switching performance, and withstand high energy pulse in the avalanche and commutation mode. The device is well suited for high efficiency fast switching applications.

Typical Applications

- Charger Adapter
- Power Tools
- LED Lighting

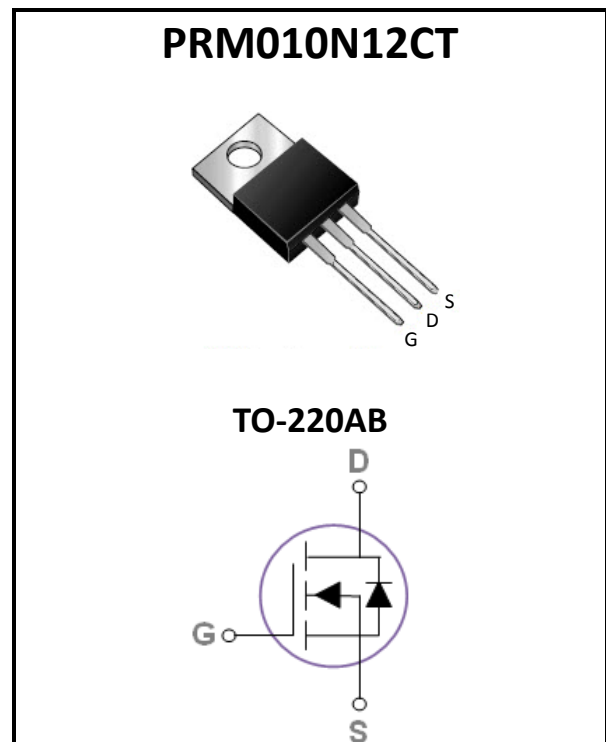

Features

- Max. $R_{DS(ON)}=10\text{m}\Omega$ @ $V_{GS}=10\text{V}$
- Improved dv/dt capability
- Fast switching
- 100% E_{AS} Guaranteed
- Green Device Available

1. Characteristics

Maximum Ratings Characteristics ($T_A = 25^\circ\text{C}$ unless otherwise specified)

Symbol	Parameter	Rating	Units
V_{DS}	Drain-Source Voltage	120	V
V_{GS}	Gate-Source Voltage	± 20	V
I_D	Drain Current – Continuous ($T_C=25^\circ\text{C}$)	71.8	A
	Drain Current – Continuous ($T_C=100^\circ\text{C}$)	45.4	A
I_{DM}	Drain Current – Pulsed ¹	280	A
E_{AS}	Single Pulse Avalanche Energy ²	151	mJ
I_{AS}	Single Pulse Avalanche Current ²	55	A
P_D	Power Dissipation ($T_C=25^\circ\text{C}$)	113	W
	Power Dissipation – Derate above 25°C	0.9	W/ $^\circ\text{C}$
T_{STG}	Storage Temperature Range	-55 to 150	$^\circ\text{C}$
T_J	Operating Junction Temperature Range	-55 to 150	$^\circ\text{C}$

Thermal Characteristics

Symbol	Parameter	Typ.	Max.	Unit
$R_{\theta JA}$	Thermal Resistance Junction to ambient	---	62	$^\circ\text{C}/\text{W}$
$R_{\theta JC}$	Thermal Resistance Junction to Case	---	1.1	$^\circ\text{C}/\text{W}$



Electrical Characteristics ($T_J = 25^\circ\text{C}$ unless otherwise specified)

Off Characteristics

Symbol	Parameter	Conditions	Min.	Typ.	Max.	Unit
BV_{DSS}	Drain-Source Breakdown Voltage	$V_{GS}=0V, I_D=250\mu A$	120	---	---	V
I_{DSS}	Drain-Source Leakage Current	$V_{DS}=120V, V_{GS}=0V, T_J=25^\circ\text{C}$	---	---	1	μA
		$V_{DS}=120V, V_{GS}=0V, T_J=125^\circ\text{C}$	---	---	250	μA
I_{GSS}	Gate-Source Leakage Current	$V_{GS}=\pm 20V, V_{DS}=0V$	---	---	± 100	nA

On Characteristics

$R_{DS(ON)}$	Static Drain-Source On-Resistance	$V_{GS}=10V, I_D=20A$	---	---	10	m Ω
$V_{GS(th)}$	Gate Threshold Voltage	$V_{GS}=V_{DS}, I_D=250\mu A$	2.0	---	4.0	V
g_{fs}	Forward Transconductance	$V_{DS}=3V, I_D=20A$	---	60	---	S

Dynamic and switching Characteristics

Q_g	Total Gate Charge ^{3, 4}	$V_{DS}=50V, V_{GS}=10V, I_D=20A$	---	56	---	nC
Q_{gs}	Gate-Source Charge ^{3, 4}		---	20	---	
Q_{gd}	Gate-Drain Charge ^{3, 4}		---	7	---	
$T_{d(on)}$	Turn-On Delay Time ^{3, 4}	$V_{DD}=50V, V_{GS}=10V, R_G=6\Omega, I_D=20A$	---	26	---	ns
T_r	Turn-On Rise Time ^{3, 4}		---	73	---	
$T_{d(off)}$	Turn-Off Delay Time ^{3, 4}		---	53	---	
T_f	Turn-Off Fall Time ^{3, 4}		---	55	---	
C_{iss}	Input Capacitance	$V_{DS}=50V, V_{GS}=0V, f=1\text{MHz}$	---	4550	---	pF
C_{oss}	Output Capacitance		---	260	---	
C_{rss}	Reverse Transfer Capacitance		---	40	---	
R_g	Gate resistance	$V_{GS}=0V, V_{DS}=0V, f=1\text{MHz}$	---	2.8	---	Ω

Drain-Source Diode Characteristics

V_{SD}	Source to Drain Diode Voltage	$V_{GS}=0V, I_S=20A$	---	---	1.5	V
t_{rr}	Reverse Recovery Time	$I_S=20A, di/dt=100A/\mu s$	---	77	---	ns
Q_{rr}	Reverse Recovery Charge		---	200	---	nC

Note :

1. Repetitive Rating : Pulsed width limited by maximum junction temperature.
2. $L=0.1\text{mH}, R_G=25\Omega$, Starting $T_J=25^\circ\text{C}$
3. The data tested by pulsed, pulse width $\leq 300\mu s$, duty cycle $\leq 2\%$.
4. Essentially independent of operating temperature.



2. Characteristics Curves

Ratings and Characteristics Curves

($T_A = 25^{\circ}\text{C}$ unless otherwise specified)

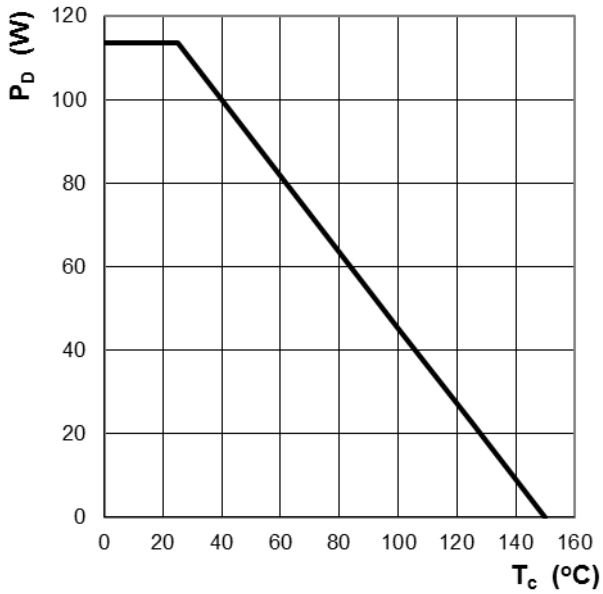

Figure 1: Power Dissipation

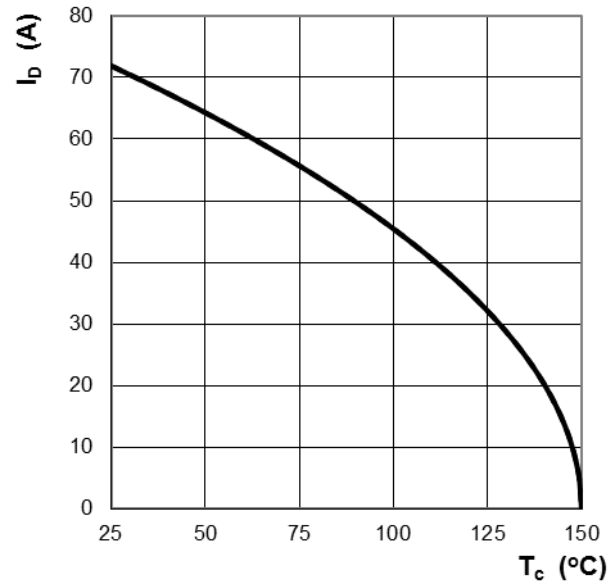

Figure 2: Continuous Drain Current vs. T_c

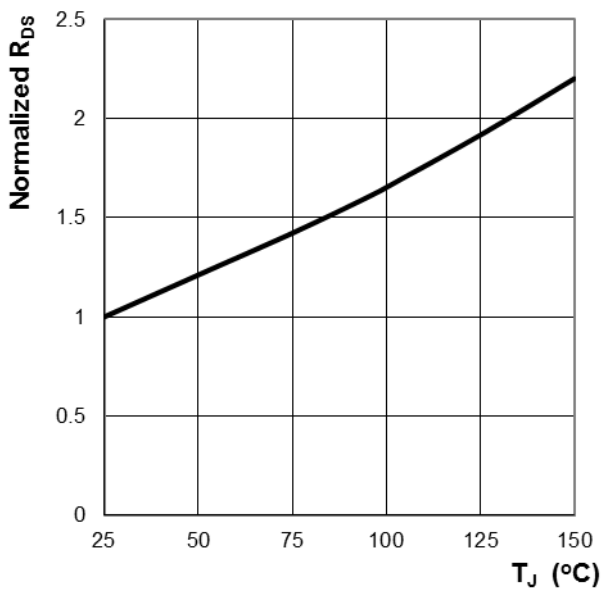

Figure 3: Normalized $R_{DS(on)}$ vs. T_J

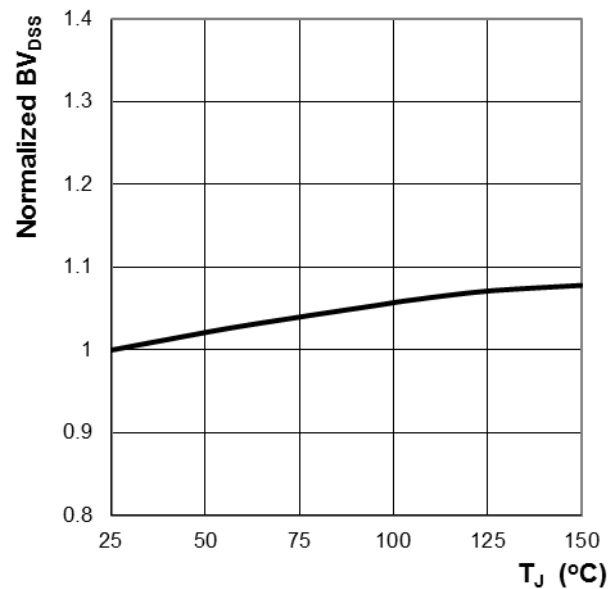

Figure 4: Normalized BV_{DSS} vs. T_J



Ratings and Characteristics Curves

($T_A = 25^\circ\text{C}$ unless otherwise specified)

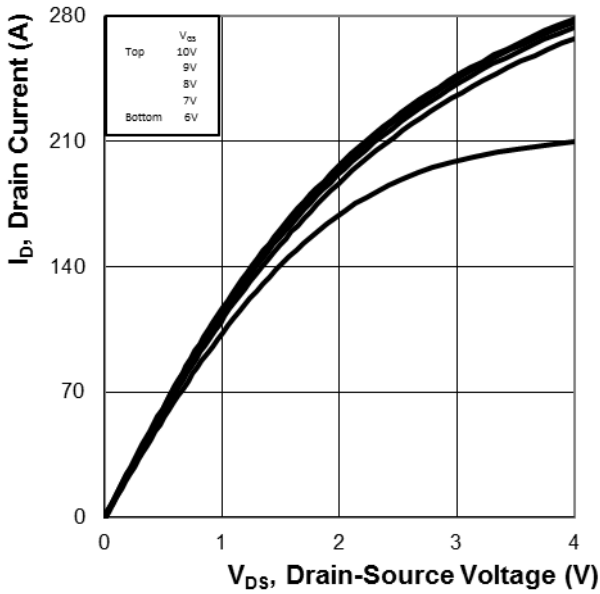

Figure 5: On-Region Characteristics

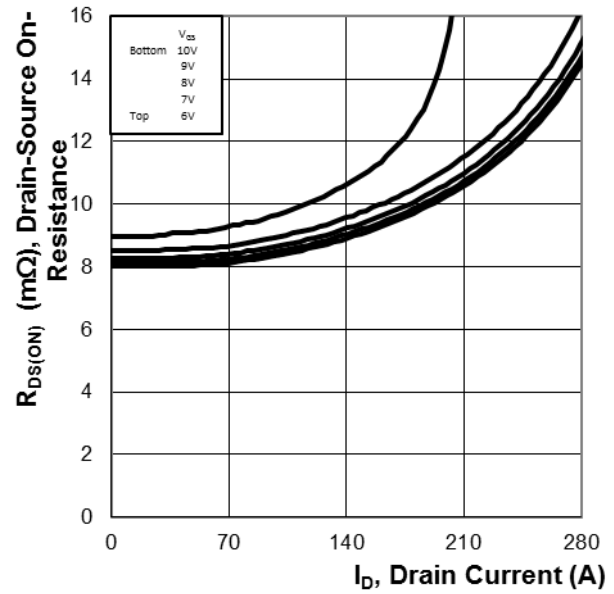

Figure 6: Typ. R_{DS} Variation vs. I_D and V_{GS}

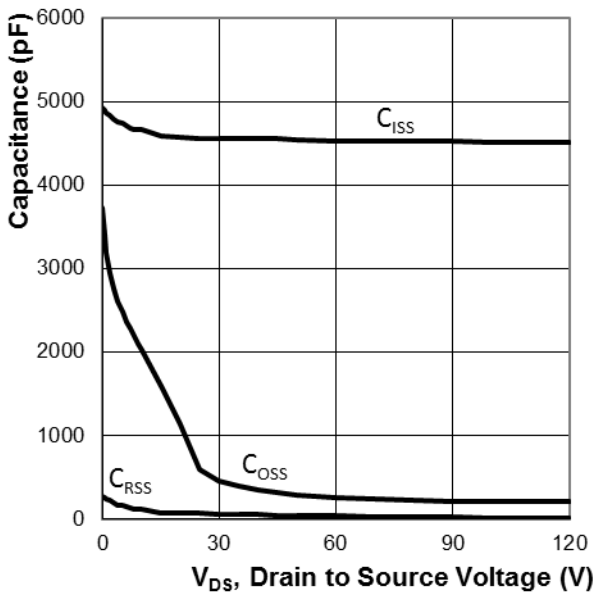

Figure 7: Typ. Capacitance Characteristics

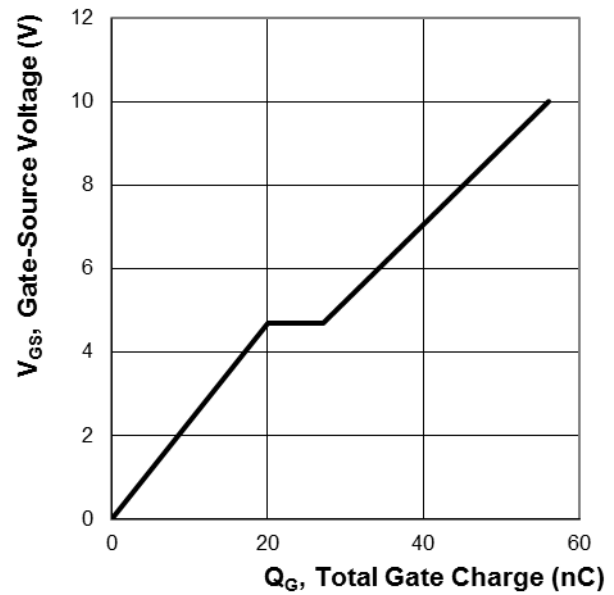

Figure 8: Typ. Gate Charge Characteristics



Ratings and Characteristics Curves ($T_A = 25^\circ\text{C}$ unless otherwise specified)

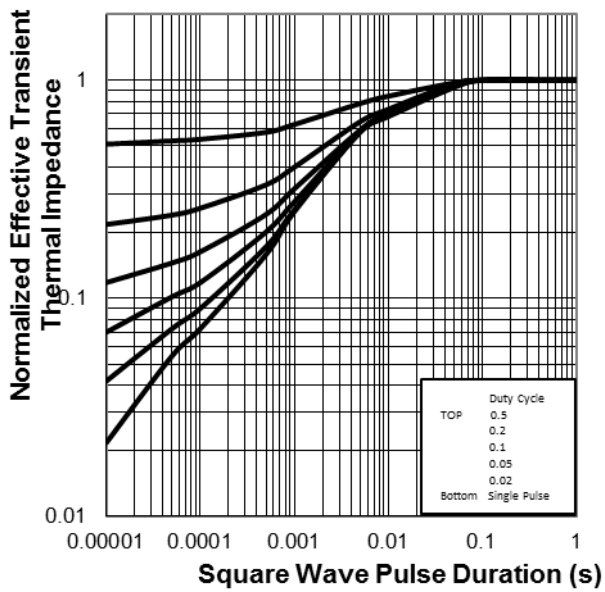

Figure 9: Normalized Thermal Transient Impedance, Junction-to-Case

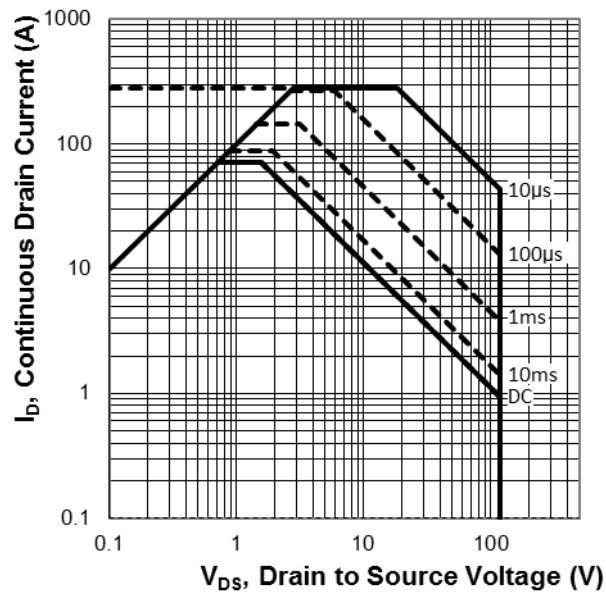
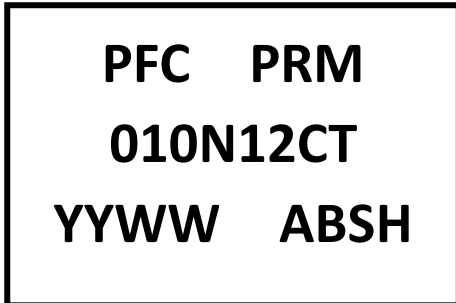

Figure 10: Maximum Safe Operation Area



3. Marking information

Top Marking Rule



PRM010N12CT = Product Type Marking Code
 YYWW = Date Code
 YY = Last two digits of year
 WW = Week code
 ABS = Assembly code
 H = Halogen Free (N/A = common molding compound)

4. Package information

Package Outline Dimensions millimeters

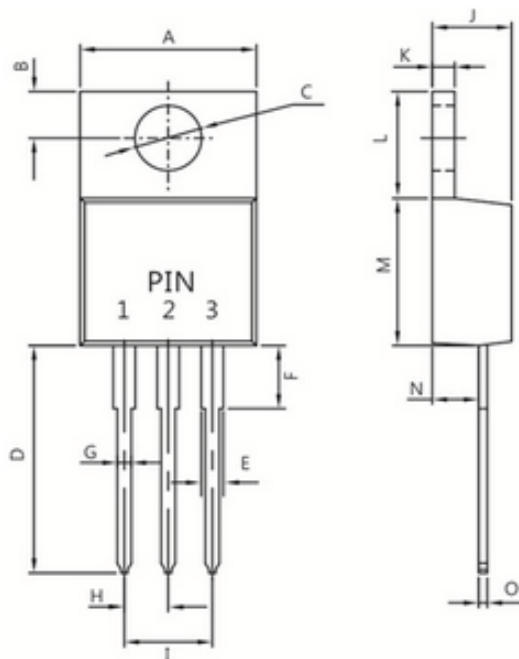

Dim.	Min.	Max.
A	----	10.50
B	2.50	3.50
C	3.50	4.10
D	13.10	13.90
E	1.15	1.45
F	----	6.35
G	0.65	0.95
H	2.29	2.79
I	4.80	5.30
J	4.40	4.80
K	1.14	1.40
L	5.84	6.86
M	8.50	9.60
N	2.03	2.92
O	0.30	0.64
All Dimensions in millimeter		



5. Ordering information

Part Number	Package	Delivery mode
PRM010N12CT	TO-220AB	50 pcs / Tube

Mechanical

- Molder Plastic: UL Flammability Classification Rating 94V-0
- Device Weight : 0.07 ounces (1.96grams) - TO-220AB
- Mounting Torque : Recommended 4~5 kg-cm

PFC Device Corp reserves the right to make changes without further notice to any products herein. PFC Device Corp makes no warranty, representation or guarantee regarding the suitability of its products for any particular purpose, nor does PFC Device Corp assume any liability arising out of the application or use of any product or circuit, and specifically disclaims any and all liability, including without limitation special, consequential or incidental damages. "Typical" parameters which may be provided in PFC Device Corp data sheets and/or specifications can and do vary in different applications and actual performance may vary over time. All operating parameters, including "Typical" must be validated for each customer application by customer's technical experts. PFC Device Corp does not convey any license under its patent rights nor the rights of others. PFC Device Corp products are not designed, intended, or authorized for use as components in systems intended for surgical implant into the body, or other applications intended to support or sustain life, or for any other application in which the failure of the PFC Device Corp product could create a situation where personal injury or death may occur. Should Buyer purchase or use PFC Device Corp products for any such unintended or unauthorized application, Buyer shall indemnify and hold PFC Device Corp and its officers, employees, subsidiaries, affiliates, and distributors harmless against all claims, costs, damages, and expenses, and reasonable attorney fees arising out of, directly or indirectly, any claim of personal injury or death associated with such unintended or unauthorized use, even if such claim alleges that PFC Device Corp was negligent regarding the design or manufacture of the part.

