



PFC Device Corporation

PT20L120SP

20A 120V HPTR[®] Schottky Rectifier

Major ratings and characteristics

Characteristics	Values	Units
$I_{F(AV)}$ Rectangular Waveform	20	A
V_{RRM}	120	V
$V_F@ 20A, T_j=125^\circ C$	0.63	V, typ.
T_j Operating Junction Temperature	-40 to +150	$^\circ C$

Features

- Super Low Forward Voltage (SLVF[®]) Drop
- Reliable High Temperature Operation
- Softest, fast switching capability
- 150 $^\circ C$ Operating Junction Temperature
- Lead Free Finish, RoHS Compliant
- Green Molding Compound (No Br, Sb)

Typical Applications

Device optimized for low forward voltage drop to maximize efficiency in Power Supply applications

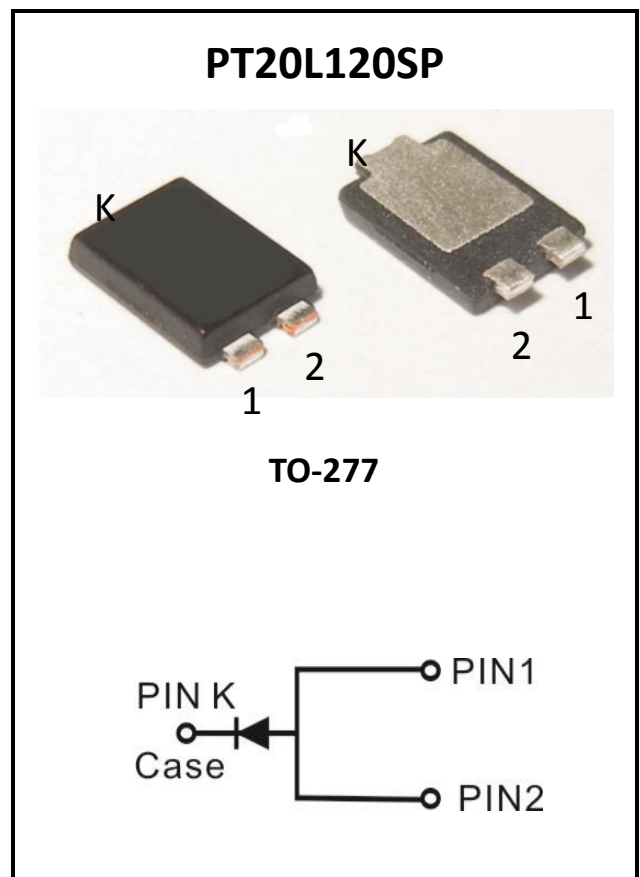

1. Characteristics

Maximum Ratings Characteristics

($T_A = 25^\circ\text{C}$ unless otherwise specified)

Parameter	Symbol	Values	Units
DC Blocking Voltage	V_{RM}	120	Volts
Working Peak Reverse Voltage	V_{RWM}		
Peak Repetitive Reverse Voltage	V_{RRM}		
Average Rectified Forward Current Per device	I_o	20	Amps
Peak Forward Surge Current - 1/2 60hz	I_{FSM}	250	Amps
Peak Repetitive Reverse Surge Current (2uS-1Khz)	I_{RRM}	1	Amps
Typical Thermal Resistance			
Thermal Resistance junction to Ambient Note (1)	$R\theta_{JA}$	72	$^\circ\text{C} / \text{W}$
Thermal Resistance junction to Ambient Note (2)	$R\theta_{JA}$	30	
Maximum Rate of Voltage Change (at Rated VR)	dv/dt	10000	V/uS
Operating Junction Temperature	T_J	- 40 to +150	$^\circ\text{C}$
Storage Junction Temperature	T_{STG}	- 40 to +150	

Electrical Characteristics - (per leg)

($T_A = 25^\circ\text{C}$ unless otherwise specified)

Parameter	Test Conditions	Symbol	Typ.	Max.	Units	
Instantaneous Forward Voltage	IF = 5 A	$T_J = 25^\circ\text{C}$	V_F^*	0.49	-----	Volts
	IF = 10 A			0.59	-----	
	IF = 20 A			0.76	0.82	
	IF = 5 A	$T_J = 125^\circ\text{C}$	0.42	-----		
	IF = 10 A	0.53	-----			
	IF = 20 A	0.63	0.69			
Instantaneous Reverse Current	VR=90V	$T_J = 25^\circ\text{C}$	I_R^*	10.0	-----	μA
	VR=120V			-----	300	μA
	VR=90V	$T_J = 125^\circ\text{C}$		8.0	-----	mA
	VR=120V			18.0	45	mA

* Pulse width < 300 uS, Duty cycle < 2%

Note 1. FR-4 PCB, 2 oz Copper. Minimum recommended pad layout

Note 2. Polyimide PCB, 2 oz Copper. Cathode pad dimensions 18.8x14.4mm , Anode pad dimensions- (5.6x14.4mm)



2. Characteristics Curves

Ratings and Characteristics Curves

(TA = 25°C unless otherwise specified)

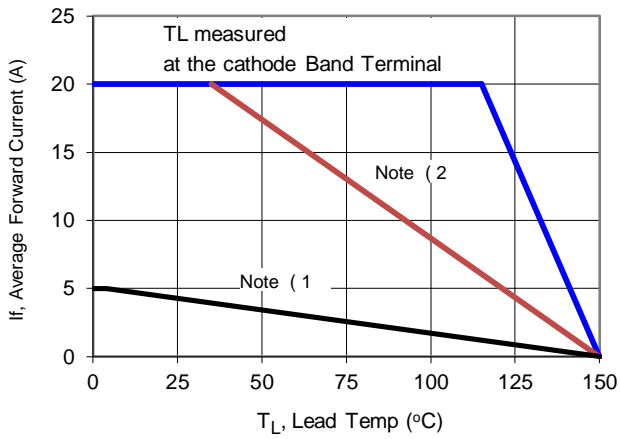

Figure 1: Current Derating, Case

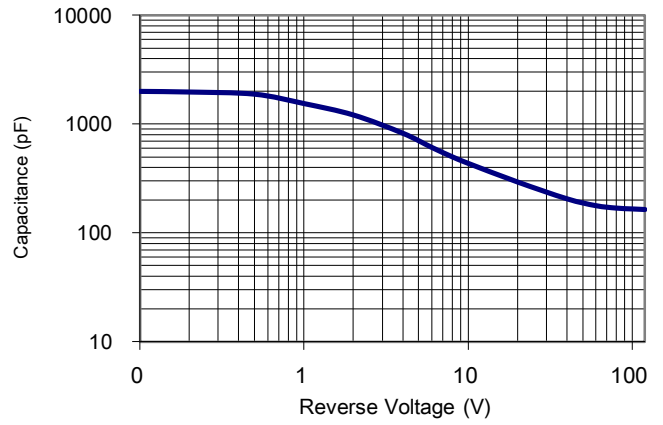

Figure 2: Typical Junction Capacitance

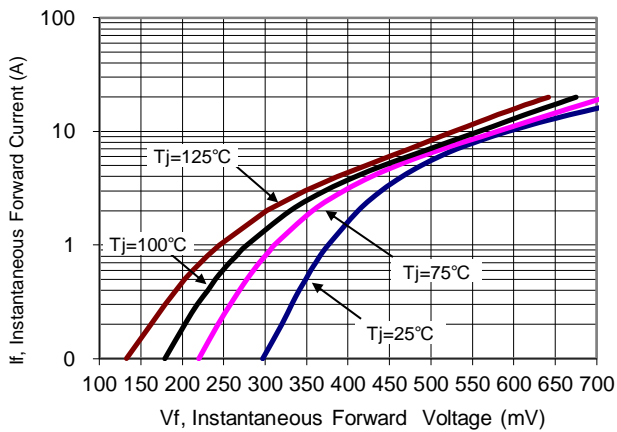

Figure 3: Typical Forward Voltage

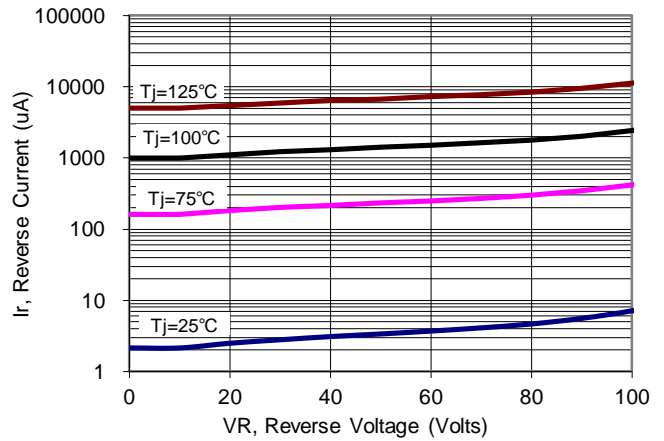
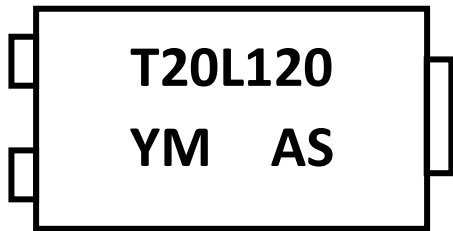

Figure 4: Typical Reverse Current



3. Marking information

Top Marking Rule



T20L120 = Product Type Marking Code

YM = Date Code

Y = Last one digits of year

M = Month code

A = Assembly Code

S = Series Number

4. Package information

Suggested Package Outline Dimensions millimeters

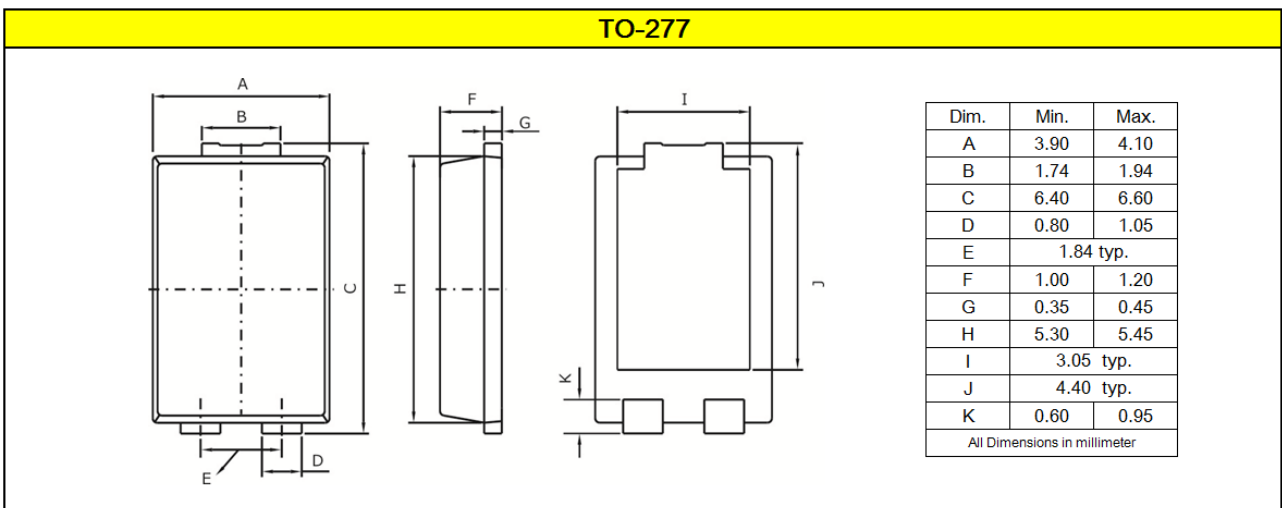

Mounting pad Outline Dimensions millimeters

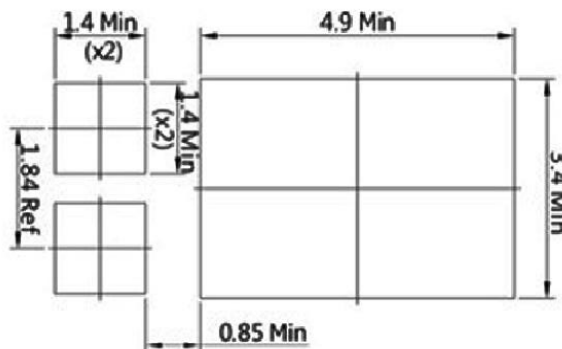

5. Packing and Ordering information

Packing information millimeters

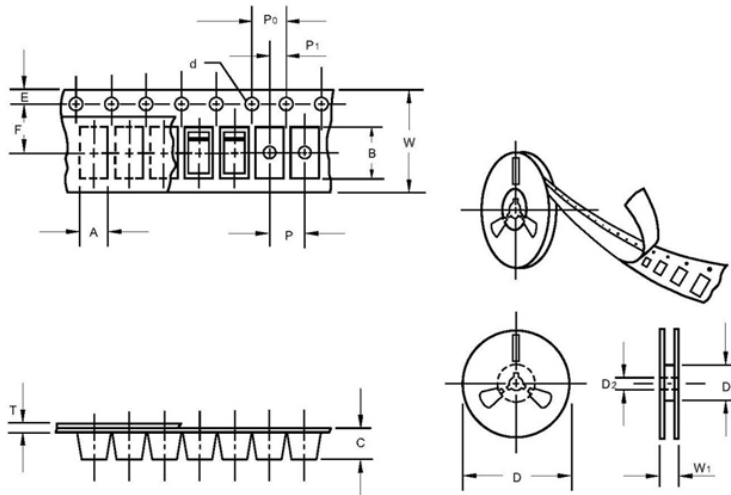

Item	Symbol	Dimension
Carrier width	A	4.4±0.10
Carrier length	B	7.0±0.10
Carrier depth	C	1.4±0.10
Sprocket hole	d	1.5±0.10
Reel outside diameter	D	330.0±1.0
Reel inner diameter	D1	75±1.0
Feed hole diameter	D2	13.5±1.0
Stocket hole position	E	1.75±0.10
Punch hole position	F	7.5±0.10
Punch hole pitch	P	8.0±0.10
Sprocket hole pitch	P0	4.0±0.10
Embossment center	P1	2.0±0.10
Total tape thickness	T	0.3±0.10
Tape width	W	16.0±0.20
Reel width	W1	22.7±1.5

Ordering information

Part Number	Package	Base Quantity	Delivery mode
PT20L120SP	TO-277	5000	13" diameter plastic tape and reel

Mechanical

- Molder Plastic: UL Flammability Classification Rating 94V-0
- Device Weight : 0.003 ounces (0.093grams) - TO-277

PFC Device Corp reserves the right to make changes without further notice to any products herein. PFC Device Corp makes no warranty, representation or guarantee regarding the suitability of its products for any particular purpose, nor does PFC Device Corp assume any liability arising out of the application or use of any product or circuit, and specifically disclaims any and all liability, including without limitation special, consequential or incidental damages. "Typical" parameters which may be provided in PFC Device Corp data sheets and/or specifications can and do vary in different applications and actual performance may vary over time. All operating parameters, including "Typical" must be validated for each customer application by customer's technical experts. PFC Device Corp does not convey any license under its patent rights nor the rights of others. PFC Device Corp products are not designed, intended, or authorized for use as components in systems intended for surgical implant into the body, or other applications intended to support or sustain life, or for any other application in which the failure of the PFC Device Corp product could create a situation where personal injury or death may occur. Should Buyer purchase or use PFC Device Corp products for any such unintended or unauthorized application, Buyer shall indemnify and hold PFC Device Corp and its officers, employees, subsidiaries, affiliates, and distributors harmless against all claims, costs, damages, and expenses, and reasonable attorney fees arising out of, directly or indirectly, any claim of personal injury or death associated with such unintended or unauthorized use, even if such claim alleges that PFC Device Corp was negligent regarding the design or manufacture of the part.

