



PFC Device Corporation

PTR20L80S
PTR20L80SF
PTR20L80SI
PTR20L80SB

20A 80V HPTR[®] Single Schottky Rectifier

Major ratings and characteristics

Characteristics	Values	Units
$I_{F(AV)}$ Rectangular Waveform	20	A
V_{RRM}	80	V
$V_F@ 20A, T_j=125^\circ C$	0.64	V, typ.
T_j Operating Junction Temperature	-40 to +150	$^\circ C$

Features

- Super Low Forward Voltage (SLVF[®]) Drop
- Reliable High Temperature Operation
- Softest, fast switching capability
- 150 $^\circ C$ Operating Junction Temperature
- Lead Free Finish, RoHS Compliant

Typical Applications

Device optimized for low forward voltage drop to maximize efficiency in Power Supply applications

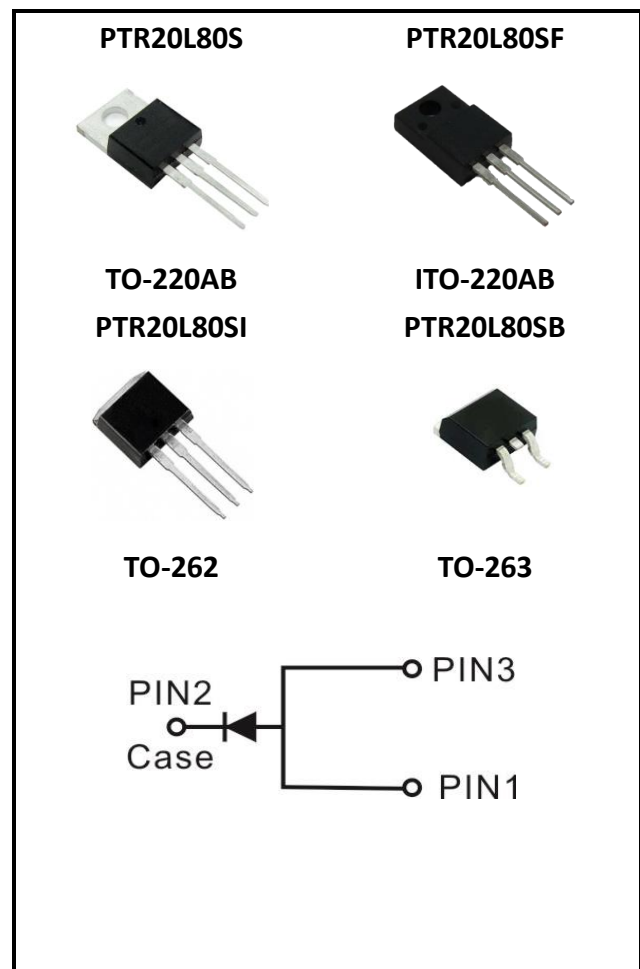

1. Characteristics

Maximum Ratings Characteristics ($T_A = 25^\circ\text{C}$ unless otherwise specified)

Parameter	Symbol	Values	Units
DC Blocking Voltage	V_{RM}	80	Volts
Working Peak Reverse Voltage	V_{RWM}		
Peak Repetitive Reverse Voltage	V_{RRM}		
Average Rectified Forward Current Per device	I_o	20	Amps
(Rated VR-20Khz Square Wave) - 50% duty cycle			
Peak Forward Surge Current - 1/2 60hz	I_{FSM}	220	Amps
Peak Repetitive Reverse Surge Current (2uS-1Khz)	I_{RRM}	1	Amps
Typical Thermal Resistance	$R\theta_{JC}$	2	$^\circ\text{C} / \text{W}$
Package = TO-220AB		4	
Package = ITO-220AB		2.5	
Package = TO-262		3	
Isolation voltage (ITO-220 only)	V_{AC}	1500	V
Maximum Rate of Voltage Change (at Rated V_R)	dv/dt	10000	V/uS
Operating Junction Temperature	T_J	- 40 to +150	$^\circ\text{C}$
Storage Junction Temperature	T_{STG}	- 40 to +150	

Electrical Characteristics - ($T_A = 25^\circ\text{C}$ unless otherwise specified)

Parameter	Test Conditions		Symbol	Typ.	Max.	Units
Breakdown Voltage	$I_R = 0.5\text{mA}$	$T_J = 25^\circ\text{C}$	V_B^*	80 (min.)		V
Instantaneous Forward Voltage	$IF = 5\text{ A}$	$T_J = 25^\circ\text{C}$	V_F^*	0.49	-----	Volts
	$IF = 10\text{ A}$			0.56	-----	
	$IF = 20\text{ A}$			0.68	0.72	
	$IF = 5\text{ A}$	$T_J = 125^\circ\text{C}$		0.4	-----	
	$IF = 10\text{ A}$			0.51	-----	
	$IF = 20\text{ A}$			0.64	0.68	
Instantaneous Reverse Current	At V_{RM}	$T_J = 25^\circ\text{C}$	I_R^*	20	300	μA
		$T_J = 125^\circ\text{C}$		14	35	mA

* Pulse width < 300 uS, Duty cycle < 2%



2. Characteristics Curves

Ratings and Characteristics Curves

(TA = 25°C unless otherwise specified)

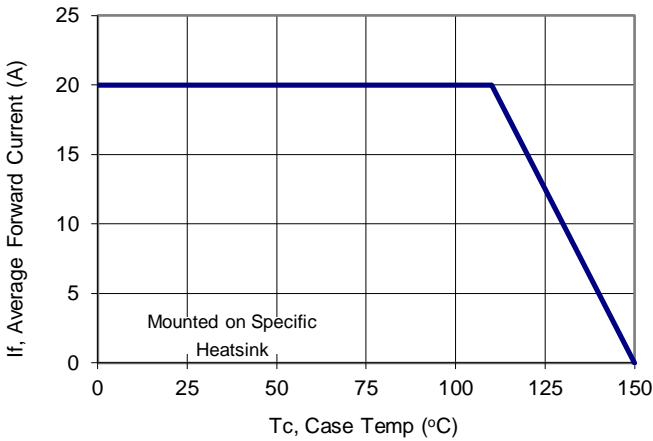

Figure 1: Current Derating, Case

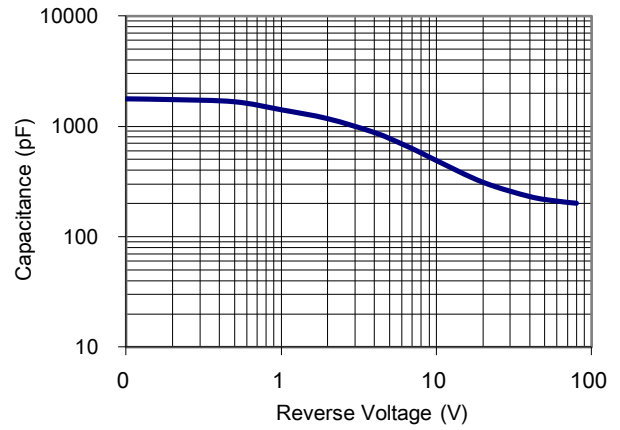

Figure 2: Typical Junction Capacitance

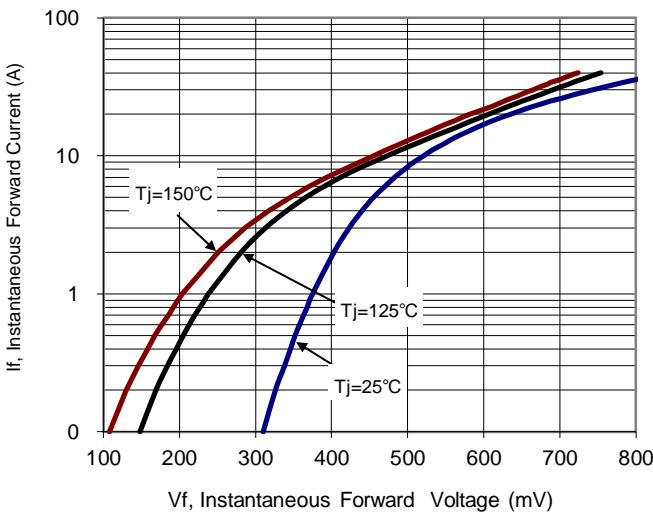

Figure 3: Typical Forward Voltage

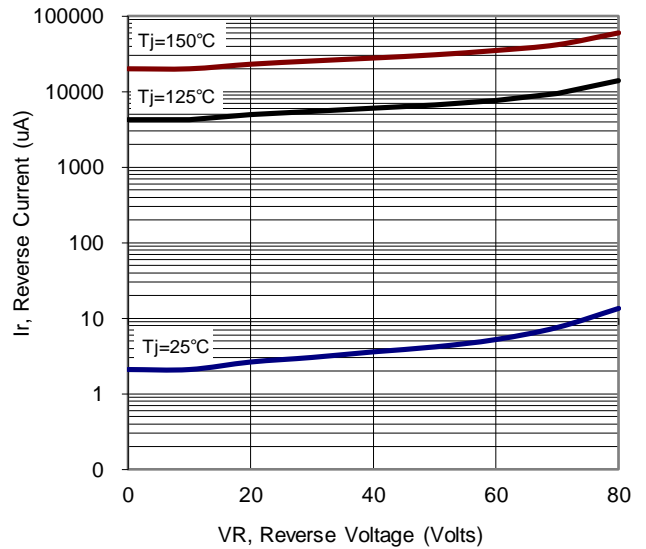

Figure 4: Typical Reverse Current



3. Marking information

Top Marking Rule

**PFC PTR
20L80S
YYWW ABSH**

PTR20L80S = Product Type Marking Code
 YYWW = Date Code
 YY = Last two digits of year
 WW = Week code
 AB = Assembly code
 S = Series Number
 H = Halogen Free (N/A = common molding compound)

**PFC PTR
20L80SF
YYWW ABSH**

PTR20L80SF = Product Type Marking Code
 YYWW = Date Code
 YY = Last two digits of year
 WW = Week code
 AB = Assembly code
 S = Series Number
 H = Halogen Free (N/A = common molding compound)

**PFC PTR
20L80SI
YYWW ABSH**

PTR20L80SI = Product Type Marking Code
 YYWW = Date Code
 YY = Last two digits of year
 WW = Week code
 AB = Assembly code
 S = Series Number
 H = Halogen Free (N/A = common molding compound)

**PFC PTR
20L80SB
YYWW ABSH**

PTR20L80SB = Product Type Marking Code
 YYWW = Date Code
 YY = Last two digits of year
 WW = Week code
 AB = Assembly code
 S = Series Number
 H = Halogen Free (N/A = common molding compound)



4. Package information

Package Outline Dimensions millimeters

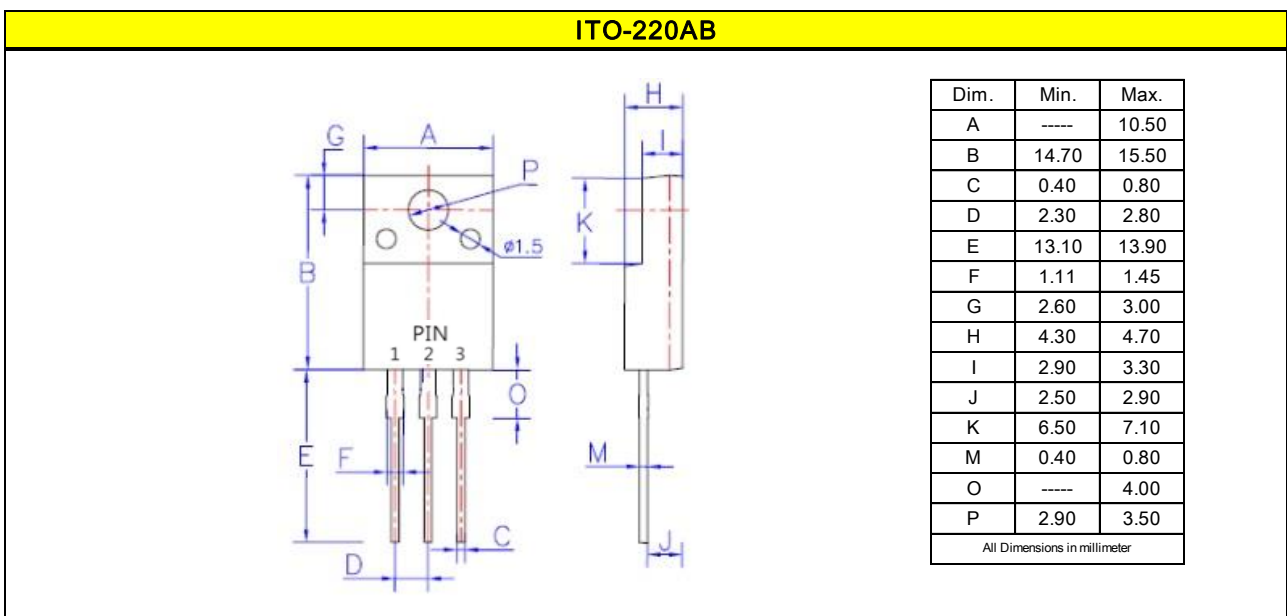
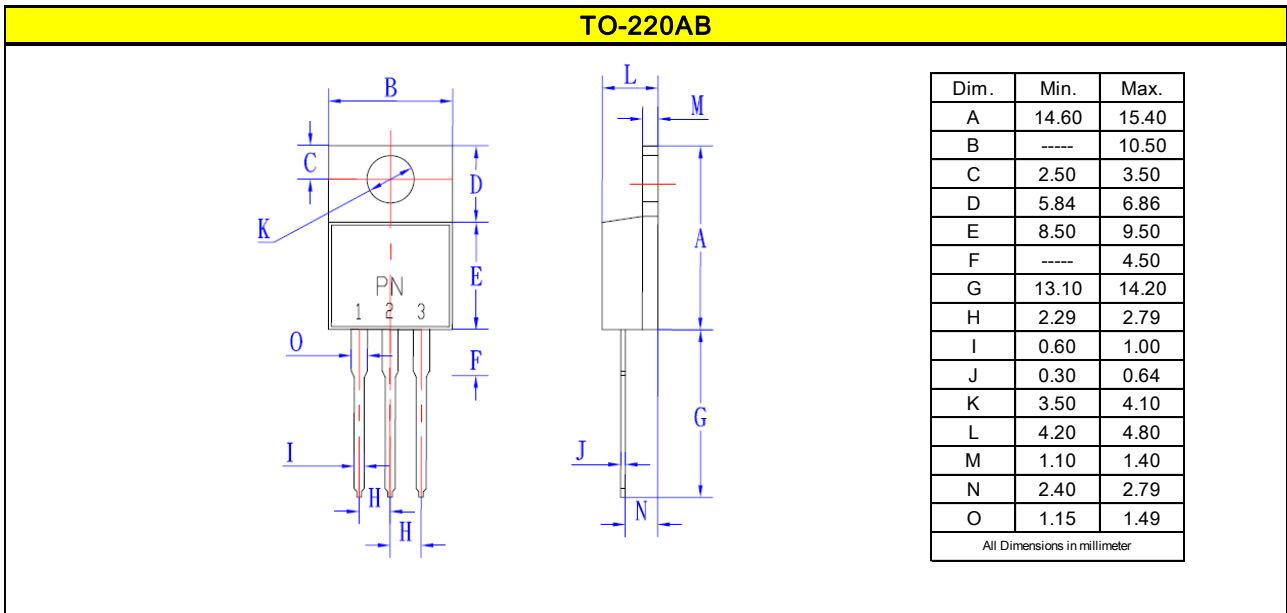

Package Outline Dimensions millimeters



5. Ordering information

Part Number	Package	Delivery mode
PTR20L80S	TO-220AB	50 pieces / tube
PTR20L80SF	ITO-220AB	50 pieces / tube
PTR20L80SI	TO-262	50 pieces / tube
PTR20L80SB	TO-263	800 pieces / 13" diameter reel

Note: For Halogen Free molding compound, add "H" suffix to part number above.

Mechanical

- Molder Plastic: UL Flammability Classification Rating 94V-0
- Device Weight : 0.07 ounces (1.96grams) - TO-220AB
 0.06 ounces (1.74grams) - ITO-220AB
 0.05 ounces (1.45 grams) - TO-262
 0.04 ounces (1.16 grams) - TO-263
- Mounting Torque : Recommended 4~5 kg-cm.

PFC Device Corp reserves the right to make changes without further notice to any products herein. PFC Device Corp makes no warranty, representation or guarantee regarding the suitability of its products for any particular purpose, nor does PFC Device Corp assume any liability arising out of the application or use of any product or circuit, and specifically disclaims any and all liability, including without limitation special, consequential or incidental damages. "Typical" parameters which may be provided in PFC Device Corp data sheets and/or specifications can and do vary in different applications and actual performance may vary over time. All operating parameters, including "Typical" must be validated for each customer application by customer's technical experts. PFC Device Corp does not convey any license under its patent rights nor the rights of others. PFC Device Corp products are not designed, intended, or authorized for use as components in systems intended for surgical implant into the body, or other applications intended to support or sustain life, or for any other application in which the failure of the PFC Device Corp product could create a situation where personal injury or death may occur. Should Buyer purchase or use PFC Device Corp products for any such unintended or unauthorized application, Buyer shall indemnify and hold PFC Device Corp and its officers, employees, subsidiaries, affiliates, and distributors harmless against all claims, costs, damages, and expenses, and reasonable attorney fees arising out of, directly or indirectly, any claim of personal injury or death associated with such unintended or unauthorized use, even if such claim alleges that PFC Device Corp was negligent regarding the design or manufacture of the part.

